

High Quality Design SPD

Contents

1.	Introduction	3
1.1	What is an SPD?	3
1.2	What does this SPD cover?	5
1.3	Who is the SPD for?	5
1.4	What is the purpose of this SPD?.....	5
1.5	When would this SPD be used?	6
2.	Preparing your application.....	6
2.1	Before applying for planning permission.....	6
2.2	Permitted Development Rights (PDRs).....	7
2.3	Submitting an application	8
2.4	How are applications assessed?	8
3.	Residential Development – Alterations and Extensions	9
3.1	Key considerations for all extensions.....	9
3.2	Extensions in the Green Belt.....	12
3.3	Side Extensions	13
3.4	Rear Extensions.....	13
3.5	Dormer Windows and Roof Extensions	13
3.6	Outbuildings.....	14
3.7	Extensions in Conservation Areas.....	14
3.8	Extensions or works to Listed Buildings.....	14
3.9	Extensions to non-designated heritage assets	14
3.10	Extensions to previously converted rural buildings.....	15
4.	Residential development - Creation of New Dwellings	15
4.1	Types of new dwellings.....	15
4.2	Key considerations for all new dwellings.....	16
5.	Conversion of Rural Buildings to Residential Use	28
6.	Non-Residential Development.....	31
6.1	Key considerations	31
6.2	Commercial Development	32
6.3	Agricultural buildings	34

6.4	Equestrian developments	38
6.5	Retail units	40
6.6	Shopfronts.....	41
7.	Advertisements and Signage.....	45
7.1	Key Considerations.....	45
7.2	Hanging or Projecting Signs	45
7.3	Free standing signage	46
7.4	Window signs	46
7.5	Conservation Areas and Listed Buildings	46
8.	Mixed Use Development.....	46

This SPD should be read in conjunction with the National Planning Policy Framework, Planning Practice Guidance, Borough of Redditch Local Plan No.4 (2011-2030) and Worcestershire County Council standards and requirements.

1. Introduction

1.1 What is an SPD?

- 1.1.1 This Supplementary Planning Document (SPD) supplements the Boroughs adopted Development Plan and therefore reflects the Council's policies. As such it is a material consideration in the determination of planning applications and will be given substantial weight in the decision making process. An SPD guides various forms of development, ensures consistency in decision making and provides clarity for architects and agents in knowing the parameters of what is expected by the Council.
- 1.1.2 The purpose of this High Quality Design SPD is to supplement the policies in the development plan and to provide detailed guidance on how a high standard of design could be achieved in new development.
- 1.1.3 The Borough of Redditch Local Plan No 4 (Adopted 2017) contains Policy 39 'Built Environment' and 40 'High Quality Design and Safer Communities'. These Policies set out what the Council expects new developments to achieve. The purpose of this SPD is not to repeat the principles within these policies but to expand upon them and provide more detailed design guidance for applicants seeking planning permission. Local Plan Policy 40 contains an important point about ensuring good design contributes positively to making the Borough a better place to live, work and visit. This is reinforced by the National Planning Policy Framework (NPPF) (paragraph 64) which states that, *"Permission should be refused for development of poor design that fails to take the opportunities available for improving the character and quality of an area and the way it functions."* This is a philosophy which will be carried throughout this SPD.

Policy 39 Built Environment

Policy 39

39.2 All development in the Borough should contribute positively to the local character of the area, responding to and integrating with the distinctive features of the surrounding environment, particularly if located within a historic setting.

39.3 All development proposals should:

- i. seek to optimise the potential of the site to accommodate sustainable development through making the most efficient use of the space available;
- ii. be innovative and resilient to the effects of climate change, whilst also protecting and enhancing locally distinctive and historic features to improve the character and quality of the local environment; and
- iii. incorporate features of the natural environment including Green Infrastructure into the design to preserve and continue Redditch's unique landscape features;

39.4 To ensure character and appearance isn't compromised, temporary buildings will be approved for a maximum of 3 years where it is related to an approval for a permanent building.

The Borough Council will not look favourably on applications for renewal of temporary permissions.

39.5 Areas should be designed to ensure they make places better for people and proposals have demonstrated that community views have been taken into account in the design of the development.

Policy 40 High Quality Design and Safer Communities

40.1 Good design improves the local environment, helps new development to fit in with its wider surroundings and creates a distinctive sense of place. A well planned environment in which to live and work can help to fight crime and the fear of crime. By using good design the opportunities to commit crime can be limited and this can have an effect on the quality of people's lives.

Policy 40

40.2 Good design should contribute positively to making the Borough a better place to live, work and visit. All development, including proposals for individual buildings, public and private spaces and wider development schemes will be expected to:

- i. be of a high quality design that reflects or complements the local surroundings and materials;
- ii. be of an appropriate siting and layout with distinctive corner buildings, landmarks, gateways and focal points at key junctions and other important locations;
- iii. protect and enhance key vistas to create visual links between places in the Borough;
- iv. include where appropriate, public art that is well designed, takes into account the risk of crime, is integrated within the overall design and layout of the development, located where it can be easily observed, improves public outdoor space and legibility and creates landmarks;
- v. aid movement by ensuring all developments benefit from accessibility, connectivity, permeability and legibility, particularly aiding sustainable modes of movement such as walking, cycling and access to public transport;
- vi. encourage community safety and 'design out' vulnerability to crime by incorporating the principles, concepts and physical security standards of the 'Secured by Design' award scheme; providing infrastructure for policing and emergency services; and considering the incorporation of fire safety measures;
- vii. provide appropriate space for waste and recycling to minimise any adverse visual impact on the property or the street-scene; and
- viii. incorporate any relevant guidance contained within Supplementary Planning Documents, for example Designing for Community Safety and Encouraging Good Design.

1.2 What does this SPD cover?

1.2.1 This SPD focuses on how a high standard of design can be achieved on new types of development in the Borough. Design can be defined as the look, function, arrangement or workings of an area or building(s) including transport routes, waterways and open spaces. This Design SPD provides an overview of design principles and sets out the requirements the Council have when assessing planning applications.

1.2.2 The Design SPD aims to:

- Be a starting point for the design process;
- Be a practical source of ideas and suggestions; and
- Help applicants assess the issues which may arise from a proposed development.

1.3 Who is the SPD for?

1.3.1 The Council has produced this Design SPD to help anyone considering any type of building or landscaping works, whether or not it requires formal consent (planning permission). This includes:

- Home owners;
- Developers;
- Farmers;
- Local businesses including shop owners and occupiers;
- Utilities and other operators of public services;
- Agents acting on behalf of any of the above;
- Planning Officers;
- Planning Inspectors;
- Statutory and non-statutory consultees.

1.4 What is the purpose of this SPD?

1.4.1 High quality design is key to promoting sustainable development and ensures that the character and appearance of an area and the street scene in general is not harmed and also enhanced. A well-designed development will enhance the existing built and natural environment, be appropriate to its intended use and may and may include innovative design.

1.4.2 BORLP4 was adopted on 30th January 2017 and therefore the local framework and policies against which planning applications are assessed changed on that date. Although there may be previous developments in the vicinity, applications are based on their individual merits and assessed against current policy at that time. Therefore the outcome of an application will be independent of previous decisions.

1.4.3 Proposed development will need to consider its immediate locality. Consideration must be given to the type of environment surrounding the development site, as this gives an understanding as to what may be permitted. Even with smaller proposals the local context and immediate surroundings will provide some understanding as to what may be permitted, and proposed development should seek to reflect the character and principles of this immediate locality. In terms of the definition of the immediate locality, this refers to what you can immediately see around you, what is in your field of vision.

- 1.4.4 This SPD will help in the formulation of proposed development to ensure that it is policy compliant by being a reasonable scale, layout, height, material, and colour, as well as respect the existing surrounding built environment and local character.
- 1.4.5 All applications will be considered on a case-by-case basis; however, they will be judged against the relevant policies in the Borough of Redditch Local Plan No. 4, National Planning Policy Framework (NPPF) and Planning Practice Guidance (PPG) as well as the Council's relevant SPDs.
- 1.4.6 Many applicants cite precedent as a reason their Planning Application should be approved. Precedent is when a planning application may have similar elements to that of a nearby or previous development which has been granted planning permission and has been implemented. In many cases there may be similar elements to planning applications but due to the nature of planning there are usually more elements which differ, making a decision and the role of precedent complex.

"The Government attaches great importance to the design of the built environment. Good design is a key aspect of sustainable development, is indivisible from good planning, and should contribute positively to making places better for people."

NPPF Paragraph 56

"Permission should be refused for development of poor design that fails to take the opportunities available for improving the character and quality of an area and the way it functions"

NPPF Paragraph 64

1.5 When would this SPD be used?

- 1.5.1 This SPD must be used where consent is required and can be used as a guide where consent is not required, to ensure that the standards of design of all types of development are raised.
- 1.5.2 It is important to note that this guidance is not intended to be a substitute for professional advice. You are responsible for ensuring that the correct permissions are obtained before undertaking any development.

2. Preparing your application

2.1 Before applying for planning permission

- 2.1.1 Once you have decided what you want to do, you will need to design it appropriately taking into account the information within this Design SPD. You will also need to determine whether your proposal requires planning permission or if it can be undertaken via Permitted Development Rights (PDRs).

2.2 Permitted Development Rights (PDRs)

- 2.2.1 PDRs are afforded to most developments to enable owners to carry out certain works without planning permission under the Town and Country Planning (General Permitted Development)(England) Order 2015 (as amended)¹. The Order sets classes of development for which certain types of works and development can be completed without the need to apply for planning permission.
- 2.2.2 Property owners should check with the Planning Department to determine whether their property still has its PDRs before commencing any building work to the property. If PDRs have been withdrawn any works covered by the regulations must be applied for via planning permission.
- 2.2.3 It should be noted that PDRs are complex and subject to interpretation and exceptions, for instance, PDRs are restricted in Conservation Areas and different PD Rights apply to commercial development, maisonettes, flats and Listed Buildings.
- 2.2.4 Developments which can be undertaken via permitted development should take into account the information within this SPD to ensure there are no adverse impacts on neighbours. Regardless of whether formal consent is required or not, it is advised that you speak to your neighbours about the proposed development, and try to avoid impacting on neighbours privacy and amenity.
- 2.2.5 Each site or building has its own unique characteristics, and different considerations will apply to different sites or buildings. Gaining an understanding of what a sites unique characteristics are should form an important early stage in the design process.

The Planning Portal provides the most up to date guidance on PDRs and it provides useful interactive tools to assist in determining which projects would or wouldn't require planning permission. Please visit the Planning Portal website at www.planningportal.gov.uk.

For further information or clarification you can speak to the Council by:

- Contacting the Planning Services team Monday to Friday 9am to 5pm on 01527 881 770;
- Talking to a Planning Officer at Householder Planning Surgery (for domestic extensions only) Tuesdays 10am-1pm at Parkside, Bromsgrove;
- Emailing your enquiry to Newplan@bromsgroveandredditch.gov.uk; or
- Attending a pre-application discussion, which you can organise using the above contact details (please see <http://www.redditchbc.gov.uk/planning/apply-for-planning-permission/check-if-you-need-planning-permission.aspx> for relevant fees).

Many of the works allowed under permitted development and those which require planning permission also require Building Regulations approval. Please contact the North Worcestershire Building Control Department for further details at 01527 881 402 or email b.control@bromsgroveandredditch.gov.uk.

¹ Please note that there may be future changes/allowances to permitted development rights which may make some parts of this SPD obsolete.

2.3 Submitting an application

- 2.3.1 For information on the documents required for submitting a planning application, please visit the Council website: <http://www.redditchbc.gov.uk/planning.aspx>.
- 2.3.2 Please note: All plans and drawings must be drawn to an identified scale and, in the case of plans, shall show
- 2.3.3 Online applications can be made via the planning portal – www.planningportal.co.uk
- 2.3.4 It is advised you seek professional help in drawing up the plans.
- 2.3.5 The Council balance a large number of factors when determining planning applications. It is strongly advised that applicants take into account the relevant information in this SPD and policies in the BORLP4 and the NPPF before submitting a planning application. All applications will be assessed on a case by case basis taking into account the individual circumstances specific to the application. Please note that only material planning considerations will be taken into account when determining an application.
- 2.3.6 Most Planning Applications will be publicised by either a site notice or through letters to neighbouring properties. Further forms of publicity will be used where the development is a Listed Building or in a Conservation Area. For information on how, when and who the Council consult on planning applications, please see the Statement of Community Involvement which is available on Redditch Borough Council's website: <http://www.redditchbc.gov.uk/council/policy-and-strategy/planning-policies/borough-of-redditch-local-plan/statement-of-community-involvement.aspx>
- 2.3.7 Building Regulations are completely separate to Planning permission under the Town and Country Planning Legislation. The granting of approval under either does not give consent under the other. In some cases only Building Regulations approval will be needed and sometimes only planning permission, although in most cases both will be required.

2.4 How are applications assessed?

- 2.4.1 Planning Officers are required to assess each Planning Application on its own merits. It will be for the applicant to ensure they have maximised every opportunity for the scheme to be as well designed as possible and achieve the principles in this SPD.
- 2.4.2 Case Officers will consider the merits of the individual application; case officers are more likely to consider an application favourably if the development has been designed as thoughtfully as possible, incorporating the principles of this SPD.
- 2.4.3 For more information on how applications are assessed, please see the Statement of Community Involvement <http://www.redditchbc.gov.uk/council/policy-and-strategy/planning-policies/borough-of-redditch-local-plan/statement-of-community-involvement.aspx>

3. Residential Development – Alterations and Extensions

3.1 Key considerations for all extensions

- 3.1.1 When considering an alteration or extension to a property it is essential to consider whether in the first instance a property should and could accommodate an alteration or extension or not. In some cases it will not be appropriate for a property to have an alteration or extension due to a range of reasons such as character of the property or proximity to adjoining neighbours.
- 3.1.2 To determine this, there are three main issues which alterations or extension applications will need to take into account and address:
1. Developments should ensure they protect and consider the impact on neighbouring amenity.
 2. Consideration of the impact on neighbouring properties and the impact on the street scene.
 3. Extensions should enhance, protect and give consideration to any impact of the development of the existing dwelling.
- 3.1.3 Other planning considerations such as Green Belt, Highways impacts, Listed Buildings and nearby trees may need to be taken into account.
- 3.1.4 The table below details the key considerations necessary for all alterations or extensions. Sections 3.2 to 3.10 of the SPD relate to specific types of alterations or extensions, for example side or rear extensions. The key considerations should be used in conjunction with the information in these sections.

PD BOX - Some developments which can be undertaken via permitted development will break the 45 degree code. Permitted development fall-back position will be considered where proposed developments are not in accordance with the 45 degree code. The PD fall back involves considering what would be allowed through development allowed under PDRs.

PD BOX – Some dwellings benefit from Permitted Development Rights which allow for certain types of residential development to be undertaken without the need for planning permission. Please check the planning portal (<http://www.planningportal.co.uk/>) or with the planning department for whether your proposed development will require planning permission.

Complement the original property

- 3.1.5 Enhance the dwelling and protect and give consideration to any impact of the development on the existing dwelling. The alteration or extension should complement the scale, general massing and materials of the existing building and remain subservient to it. Matching bricks, roof tiles or other facing materials in form, colour and texture should be used. Where there are existing features of interest, these should be preserved.

Extensions must be subordinate

- 3.1.6 Keep width, height and bulk in proportion to the existing property, thus avoiding making the extension the central feature of the building. The form and mass of an extension should take into account the scale and mass of the existing building and be proportionate in size.

Neighbour impact

- 3.1.7 Ensure that consideration has been given to the impact on neighbouring occupiers and protection of neighbouring amenity. This can be achieved by ensuring proposals take account of:
- i) **Overlooking** – This may be a problem if a new extension allows views into the private amenity or living space of your neighbour. Problems may also arise where an extension would result in the loss of outlook. However, overlooking is desirable where the spaces being overlooked are public spaces as this provides natural surveillance and can deter criminal activity and anti-social behaviour.
 - ii) **Overshadowing** – Overshadowing occurs where a development reduces the supply of light to a neighbour's property or garden. Development should be designed to minimise impacts upon the amenity and living conditions of neighbours. The extent of overshadowing and the severity of its impacts upon amenity will depend upon:
 - a) The aspect of the development relative to the path and height of the sun;
 - b) The size and massing of the new development;
 - c) The position of the extension relative to neighbouring properties;
 - d) The nature and use of the rooms affected by shadowing;
 - e) Distance between buildings;
 - f) The presence of existing features that obstruct light; and
 - g) Ground levels.
 - iii) **Overbearance** – A development would be considered overbearing if it dominated, overwhelmed, or had a visually intimidating impact on a neighbouring property. Overbearance can occur when an extension is positioned too close to a property boundary and has sufficient height and mass to dominate its neighbour. To ensure overbearance does not occur, the 45 degree code can be used. The code is not a definitive rule, as other considerations will be taken into account, such as orientation, levels, distances and permitted development fall back (this involves considering what would be allowed through development allowed under PDRs). A 45 degree line is drawn from the closest edge of the nearest rear habitable window of the neighbouring property. Habitable rooms do not include bathrooms, hallways, utility rooms and circulation space. If there are two rear windows in a room, the impact on the closer one would be considered.

Figure 1

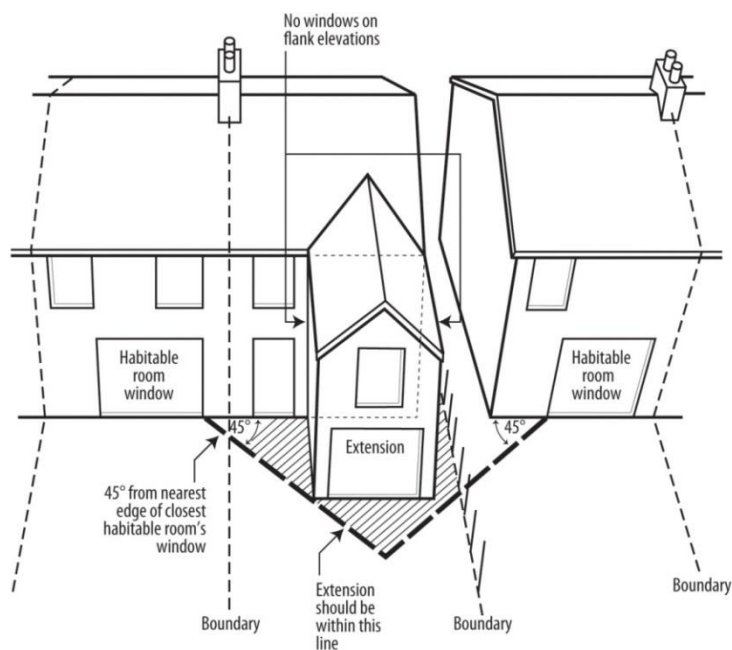
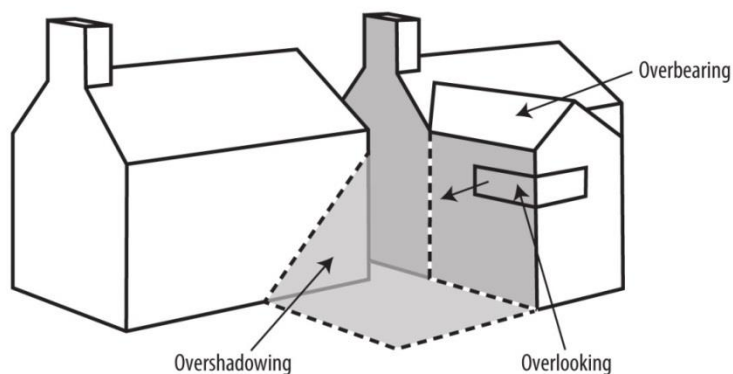

Figure 2



Roofs

- 3.1.8 The roof form (type and angle of pitch) should match that of the original development, (particularly where a two storey extension is proposed) and that of the adjoining property. This contributes to the harmony of the building and avoids the long term maintenance problems associated with flat roofs.

Windows and doors

- 3.1.9 Proposed openings should align horizontally and vertically to those in the existing property, as should other details such as sills and lintels. These features must be of a similar or matching design and size. This ensures that the harmony of the building is not disrupted. Dormer windows should not be deeper than half the depth of the roof slope, and ensure that they have square proportions or a vertical emphasis. They should be in keeping in terms of scale within the building and the street-scene.

- 3.1.10 Windows and doors installed in an extension or as part of an alteration should be certified to security standards approved by Secured by Design, in order to reduce the risk of crime.

Street scene

- 3.1.11 An alteration or extension or alteration must consider the impact on the street scene. An alteration or extension must:
- i) Enhance and strengthen the local distinctiveness of an area, for example reflect the pattern and spacing of buildings;
 - ii) Not normally project forward of the principle elevation, or that fronting the public domain. One exception would be the addition of a porch; and
 - iii) Respect local styles and features to maintain local distinctiveness.

Nesting birds/ bat roosts

- 3.1.12 The impact of the alteration or extension on protected and other species such as House Martins, Swallows and Swifts must be considered. It must also be ensured that suitable protection, conservation, enhancement or mitigation measures are undertaken.

Attached garages

- 3.1.13 Proposals for attached garages will be considered as extensions.

3.2 Extensions in the Green Belt

- 3.2.1 Extensions in the Green Belt will be assessed against Policy 8 of BORLP4 which complements the NPPF. The extension must also meet the following size requirements:

Extensions to existing residential dwellings up to a maximum of 40% increase of the original dwelling or increases up to a maximum total floor space of 140m² ('original' dwelling plus extension(s)) provided that this scale of development has no adverse impact on the openness of the Green Belt;

- 3.2.2 For the assessment of residential extensions in the Green Belt the above requirement is divided in to two separate elements:
- i) Either the extension is considered under the first part of the requirement– a maximum 40% increase of the original dwelling; **OR**
 - ii) The total floor space increases to a maximum of 140m² made of the original floor space of the dwelling plus the floor space of the proposed extension.
- 3.2.3 In the same way that a 'proportionate addition' is not defined in the NPPF, there is not a definitive guide to how a 40% increase should be calculated. It can be calculated either as floor space or volume.
- 3.2.4 All measurements must be taken externally.
- 3.2.5 An assessment to consider the impact of the proposal on the openness of the Green Belt can be undertaken in a number of ways. Generally, openness is considered to be the absence of buildings and development. However, positioning, mass, height and

topography can all have an impact on this; in addition openness is a wider concept than that of the visual impact of the development on the Green Belt.

PD BOX – Some front extensions, such as porches can be undertaken under permitted development provided they meet certain requirements.

3.3 Side Extensions

- 3.3.1 Side extensions will be required to be subordinate in size and prominence. To achieve this, extensions should be clearly set down from the ridge of the dwelling and set back from the principle elevation. Each application will be considered on its own merits to ensure that the design of the side extension is appropriate to that property and its surroundings.
- 3.3.2 Extensions should reflect the proportions of the original building. To achieve this, an extension should be of a smaller and less substantial scale than the main building, as over-large extensions can unbalance the proportion and harmony of the host building and can also have a detrimental effect on the street scene as a whole.
- 3.3.3 Side extensions to dwellings on corner plots must respect the building line of both street frontages, providing interest on both elevations and avoiding blank elevations.

Figure 3

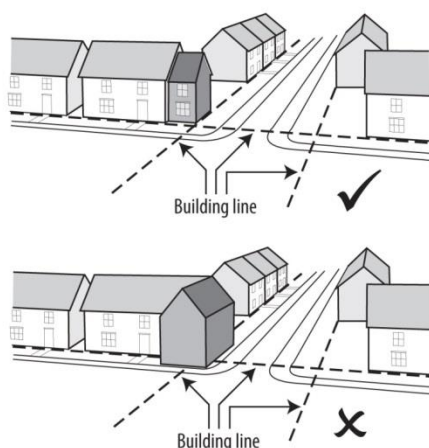

3.4 Rear Extensions

- 3.4.1 Although the rear of dwellings are usually the least prominent in public views, reduced visibility is not an excuse for poor design. The general objective remains to produce harmonious extensions which do not harm the amenity of neighbouring properties.
- 3.4.2 Two storey extension proposals should always match the main pitch of the roof.
- 3.4.3 Rear extensions should not cause overshadowing or be overbearance to neighbouring dwellings and gardens.

3.5 Dormer Windows and Roof Extensions

- 3.5.1 Dormer windows and roof extensions can detract from the form and appearance of the original dwelling. Dormers which require planning permission will only be allowed where they are below the ridgeline and set away from the edges of the roof, subject to

the character of the original dwelling. Dormers should preferably be pitched rather than flat roofed, and restricted in number and size in order to avoid a top heavy or unbalanced appearance.

3.6 Outbuildings

- 3.6.1 Outbuildings can include detached garages and sheds. Where outbuildings require planning permission they should be of an appropriate scale, orientation and design to ensure they do not compete with or detract from the dwelling they serve.
- 3.6.2 Proposals should respect the design, materials and form of the original building, its setting and the residential amenities of neighbours.
- 3.6.3 Outbuildings set forward of the principle elevation will not usually be appropriate as it may harm the character of the street scene.
- 3.6.4 They should be of appropriate size and orientation to achieve their intended use while not being of such a scale to detract from the existing dwelling.

3.7 Extensions in Conservation Areas

- 3.7.1 Where extensions to dwellings are proposed in Conservation Areas the impact on the character of the Conservation Area as a whole must be considered, not just the street scene. Due to the nature of most Conservation Areas, particularly the rural ones, other spaces and elevations can be visible. Proposals must preserve or enhance the character and appearance of the Conservation Area in terms of new development.
- 3.7.2 A starting point for any scheme should be a Heritage Statement which identifies the character and significance of the Conservation Area and the site in question, this should explain how the proposed scheme preserves or enhances the Conservation Area. Where there is a valid Conservation Area Appraisal and Management Plan, this should be referred to in the Heritage Statement. Guidance and discussion should be had with the Conservation Officer prior to a planning application being submitted.

3.8 Extensions or works to Listed Buildings

- 3.8.1 A starting point for any potential works to a Listed Building should be a Heritage Statement. The Heritage Statement must identify the character and significance of the Listed Building; this should inform whether works or a proposed extension is appropriate in relation to the historic nature of the building. The Heritage Statement will also help guide appropriate application and type of materials as well as the form and massing of a potential extension.
- 3.8.2 Works to Listed Buildings including interior alterations will require Listed Building Consent. Guidance and discussion should be had with the Conservation Officer prior to a planning application being submitted.

3.9 Extensions to non-designated heritage assets

- 3.9.1 A non-designated heritage asset is an asset of historic value which is not designated nationally, but is of local importance. Please be aware the Council do not have a definitive list of non-designated heritage assets, they are often identified through the submission of planning applications.

- 3.9.2 In weighing applications that affect non-designated heritage assets a balanced judgement will be required having regard to the scale of any harm or loss and the significance of the heritage asset.

3.10 Extensions to previously converted rural buildings

- 3.10.1 Extensions will not normally be permitted as these detract from the plain, simple and utilitarian appearance of most rural buildings.
- 3.10.2 Where extensions to previously converted rural buildings are proposed they will be treated differently to extensions on purpose built dwellings. The original nature and character of the building should have been retained through the conversion, and it should be retained where extensions are proposed. Proposed extensions must reflect the form, character and utilitarian nature of the building and proposed openings should reflect the character and scale of the original building. Materials should match those of the existing building and where possible, thoughtfully reclaimed materials should be used to blend the old and new sections together.
- 3.10.3 Conservatories, including lantern style orangeries, will not be permitted as they do not reflect the character of the original building.

4. Residential development - Creation of New Dwellings

“Although visual appearance and the architecture of individual buildings are very important factors, securing high quality and inclusive design goes beyond aesthetic considerations. Therefore, planning policies and decisions should address the connections between people and places and the integration of new development into the natural, built and historic environment.”

NPPF Paragraph 61

4.1 Types of new dwellings

4.1.1 This section sets out the various requirements for new dwellings. In the Green Belt new dwellings will generally not be permitted.

A) Replacement dwellings

- Replacement dwellings are considered by the Council as new dwellings.
- Replacement dwellings should be sited comfortably within the plot, follow the established building line and take into account the majority of key considerations in Section 4.2, where applicable.

B) Small scale development (1-9 dwellings)

- Small scale developments can have a great impact on the character and nature of an area. The below key considerations (section 4.2) will need to be taken into account as well as whether the development is part of a plot subdivision or back-land development.
- Plot subdivision will be resisted in most cases unless the plot is of sufficient size for both the existing and proposed development and no adverse impacts result from the development to either the proposed or existing dwelling(s). Plot subdivision which adversely impacts the grain of the existing area will be strongly resisted.
- Back land development or rear-garden development will be resisted, in line with Policy 5 (of BORLP4).

C) Large scale development (10 or more dwellings)

- Developments of more than 10 dwellings will require a considered approach taking into account the below key considerations (Section 4.2) as well as the detailed layout of the site and the Council's requirement for affordable housing and public open space.
- Contributions may be sought in line with current national and local policy.
- Affordable housing should be integrated into the site and should be indistinguishable from market housing to ensure a cohesive community is created.
- Sustainable Drainage Systems (SuDS) will be required on site to mitigate the impact of the development on flooding and surface water runoff. Suitable SuDS should be used for the scale of the development site and should be integrated into the design from the beginning.

D) Conversion of Rural Buildings to Residential Use

- These applications are treated differently to other types of new dwellings. Please see section 5 for more information.

4.2 Key considerations for all new dwellings

- 4.2.1 There are a number of principles which should be given due consideration to ensure that the design of new development is of a high standard. It is important that new housing is appropriately designed to deliver sustainable and attractive environments in Redditch Borough for both new and existing residents.
- 4.2.2 The key considerations which should be taken into account for the development of all new dwellings, including replacement dwellings (unless otherwise stated) are detailed below.

Layout and surroundings

Layout

- 4.2.3 New residential developments will be required to be suitably sited taking into account neighbouring dwellings, the size of the plot and the orientation of the sun. New developments should be legible with easily identified landmark buildings and clear and accessible links through the site.
- 4.2.4 Urban block layouts provide an efficient template, with building fronts and entrances to public spaces and private backs to private spaces. Such layouts minimise the creation of unsupervised and unsafe public spaces and unsafe access routes.

Infill

- 4.2.5 Where infill is proposed, it must reflect the existing urban form (see Figure 4 below).

Figure 4

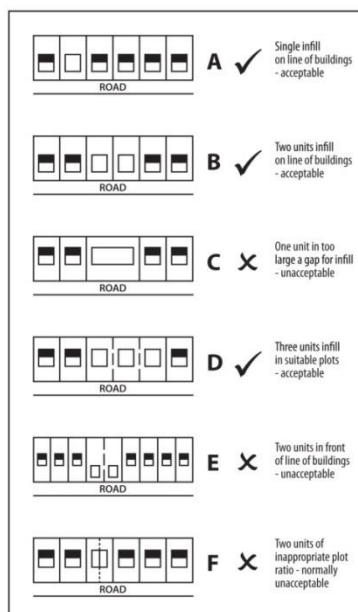

Adequate bin storage

- 4.2.6 Accessible refuse stores within new developments should be provided. The size of the bin storage will be influenced by that of the containers housed. In designing and positioning refuse stores it is important to balance the functional requirements of servicing against other design objectives. Bins storage should be well designed and integrate with the property and curtilage to allow bins to be unobtrusive on the street scene.
- 4.2.7 Bin storage areas must be well designed and located in relation to properties. If the bin store is a gated under cover enclosure, it will require enough room to move bins through the opening and for easy access.
- 4.2.8 The access from the storage areas to the nearest vehicle access:
- Should be no further than 30 metres from the access roadway;
 - Should be free from steps and kerbs;
 - Should be smooth with a continuous finish;
 - Should be level with a gradient falling away from the store of less than 1:14; and
 - Should be a minimum width of 2 metres in the case of communal bins
- 4.2.9 Communal bin stores will be required to:
- Provide suitable capacity to allow for correct number of bins (based on 240 litre per fortnight waste and 240 litre per fortnight recycling per dwelling for capacity);
 - Use fewer communal bins of larger sizes where possible ;
 - Be fire proof in its construction;
 - Be designed to encourage the correct sorting and storing of recyclable and non-recyclable materials;
 - Be conveniently located for use of all residents;
 - Ideally have a locking mechanism that does not require keys; coded locks are preferable; and

- g) Ensure the provision does not have an impact on the amenity of occupiers.

Local character

- 4.2.10 Residential development should embody the particular characteristics of the built and natural environment in which it is located to provide a sense of place and identity. The use of particular materials and details in construction, the mix of building types, periods and styles, the street pattern and street furniture, the layout, scale and massing of buildings or arrangement and landscaping of spaces can be reflected in new development to ensure it retains and enhances the local character of an area. Applicants should identify the features that make a place distinctive and then identify how the proposal can retain these features and enhance them.

Views and vistas

- 4.2.11 The development should retain, enhance and/or create views, vistas, skylines, landmark buildings and other features such as trees, hedgerows and other landscape features where possible. Views of local landmarks should remain visible to enable legibility. Where appropriate, development can frame locally important views through the creation of boulevards which direct the eye or strategic gaps in development.

Topography

- 4.2.12 Developments should work with the contours of the site to ensure overlooking; overbearance and overshadowing are not issues.

Urban grain

- 4.2.13 The pattern of the arrangement of street blocks, plots and their buildings in a settlement should be continued through any new development to ensure proposals successfully integrate into the existing urban fabric.

Streetscape

- 4.2.14 Developments should fit suitably into the streetscape and follow the established building line. Materials for developments should reflect those in the existing vicinity in order to harmonise existing and new development. As a general rule all development should be positioned to front onto the street.

Corner plots

- 4.2.15 Where buildings are situated at corner plots they should 'wrap-around' the corner or be double-fronted to ensure that both sides front onto the street make a positive contribution to the street scene and natural surveillance is provided to both frontages.

Connectivity

Ease of movement

- 4.2.16 An area must have a variety of pleasant, convenient and safe routes through it. New developments should offer a choice of routes to, from and through the site, with a preference towards walking and cycling. Developments which are easy to navigate and are well connected should in turn make residents and visitors feel safe and secure.
- 4.2.17 The needs of pedestrians and cyclists should be put before the needs of vehicles with appropriate traffic calming measures that are integral to the overall design. All routes should be designed having regard to the needs of all people including the mobility and visually impaired, in order to promote greater activity, and so increase the natural surveillance.
- 4.2.18 Footpaths and cycle paths should be as direct as possible and should be more convenient than vehicle routes. Paths must be well-lit, short, straight and not run at the side or rear of properties. Integrated routes are preferable, that is those that run alongside vehicle routes. Where integrated routes are not possible, the pedestrian and cycling routes must benefit from natural surveillance.
- 4.2.19 Residential developments must carefully consider designing for through movement in order to provide an appropriate degree of connectivity. Where included, pedestrian through-routes must be integrated into the local movement network so that they connect to locations where residents want to go and as such are well-used. Providing too many footpaths dilutes pedestrian activity and may increase the fear of crime along these routes, discouraging residents from choosing to walk or cycle. Where through-footpaths are required within a development they must be desired/well-used, short, wide, well-lit and subject to good surveillance from the active rooms of neighbouring properties. They must not run at the side or rear of properties and must not contain possible hiding places.

Interconnectivity with the surrounding area

- 4.2.20 Development must be well connected to and integrated with the surrounding area and ensure ease of movement, with safe, direct and meaningful connections to the network of pedestrian and cycle routes in the wider area. How networks connect locally and more widely, and the way developments, routes and open spaces relate to one another should be designed in to new development.

Legibility

- 4.2.21 The development will enhance the legibility of the Borough through the appropriate design and siting of distinctive corner buildings, landmarks, gateways and focal points at key junctions and other important locations; and by the protection and enhancement of key vistas that create visual links between places.

Neighbourhood

- 4.2.22 Proposals should make appropriate connections between the site and neighbouring buildings, spaces and features. Developments should integrate well with the existing built environment and enhance existing features.

Cycle storage

- 4.2.23 Adequate cycle storage for residents of the property of an appropriate size should be included as part of the development. These standards are set out by Worcestershire County Council Highways Department. Please refer to their specific requirements regarding cycle storage.
- 4.2.24 Cycle parking should be located where it benefits from good natural surveillance from active streets, buildings and passing motorists.

Electric car charging points

- 4.2.25 Developments should consider the inclusion of electric car charging points and are encouraged to be incorporated as part of the scheme.

Road Design

- 4.2.26 Surface materials should be selected that are robust, suitable for the use, easy to maintain and that respect the character of the area.

Amenity

Private Amenity Space and Spacing Standards

- 4.2.27 Private amenity space will be required to be of a usable size, with a minimum of 70sqm for dwellings. Amenity space in the canopy of trees or on a steep gradient will not be included within the 70sqm requirement. A more flexible approach will be used for communal amenity space for flats. Rear private amenity space will usually be expected to be a minimum of 10.5 metres in length for a two storey dwelling. This applies independently of the minimum amenity space requirement. Private amenity space will be expected to be suitably sited and in scale with the plot and surrounding buildings and reflect existing local density.
- 4.2.28 Gardens should be located to the rear of buildings, and wherever possible, back onto other gardens or open spaces.
- 4.2.29 21m will be required between rear dwelling windows that directly face each other. Where there is a difference in gradient further distance may be required (please see Figure 5 below).

Figure 5

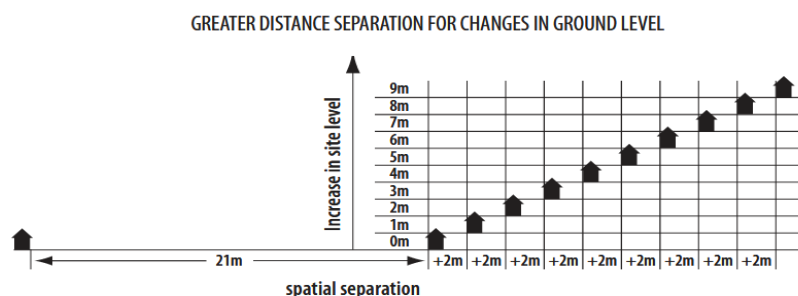

4.2.30 Balconies will only be acceptable where it can be demonstrated that the privacy of adjacent residents can be safeguarded by ensuring that there is no direct overlooking of windows or, at close quarters, the rear gardens of adjacent dwellings.

Public open space

4.2.31 For larger residential development Open space should be located in a prominent position which maximises natural surveillance from surrounding development, should be easily accessible from the whole development and be of a sufficient size to provide a variety of uses. Small ‘pocket’ parks will not be permitted. Public space boundary treatments should allow clear views into and out of the site. (For more information on the design of Open Space please see the Open Space SPD).

4.2.32 Play areas for younger children should be designed so that they are safe locations for children to occupy. Whilst play areas should be close enough to properties to allow for natural surveillance.

Street Furniture

4.2.33 For larger residential development there should be a co-ordinated approach to the provision of all street furniture and this should be appropriately sited and designed to reinforce the character and identity of the area and to ensure it benefits from natural surveillance.

Car Parking

4.2.34 Where car parking within a residential building curtilage is provided, measures should be taken to mitigate its impact on the building by locating the garage or car-port alongside the house and set back from the building-line. Where garages are provided, the entrances should be located towards the front of dwellings where they can easily be seen and accessible. Flat roofs should be avoided. Incorporating garages into the main form of the dwellings should be avoided.

4.2.35 In appropriate circumstances consideration should be given to on street parking in designated parking bays.

4.2.36 Courtyard parking should be located to the rear of development and be well lit, overlooked by adjoining properties and in general not include more than 10 spaces. The entrance(s) to the courtyard between buildings or through an archway needs to respect the street frontage and avoid harming the continuity of the street.

- 4.2.37 Parking courtyards should be clearly defined as private space using symbolic boundary treatments, and where appropriate the use of gates. Where gates are provided they should make a positive contribution to the building or street scene and should be set back from the highway.
- 4.2.38 Where shared driveways are proposed, they should be designed to provide sufficient width to allow cars from both properties to be parked, car doors to be opened (without touching the other car) and room to allow wheelie bins to be moved past the vehicle.
- 4.2.39 Parking should be designed to adapt the users preferences therefore where possible, should be in close proximity to their property, with a direct line of sight.

Boundary treatments

- 4.2.40 Boundary treatments should utilise existing features and vegetation, such as hedgerows and mature trees.
- 4.2.41 Buildings and structures should be arranged to clearly demonstrate which areas are private and public, with a range of physical or symbolic boundary treatments used, depending on the context. Boundary treatments may include symbolic barriers, such as subtle changes in paving material, or physical barriers as such as gates, fences, walls and hedges.
- 4.2.42 The choice of boundary treatments should relate to the wider physical, social and physical and social context of the surrounding environment and seek to make a positive contribution to the character of the area and the building(s).
- 4.2.43 Where they are adjacent to public spaces, boundary treatments should allow clear views into and out of the site and not hinder vision on the highway, particularly at road junctions.
- 4.2.44 Boundary treatments should comply with the Secured by Design guidance. 'Aggressive' boundary treatments (such as razor-wire, barbed wire or bare metal palisade fencing with spiked pales) are not recommended in a residential setting. Careful attention must be paid to the design and construction of boundary treatments in order to avoid the creation of climbing aids.

Overlooking

- 4.2.45 Overlooking may be a problem if new development allows views into the private amenity (including outdoor space) or living space of a neighbouring property. The impact of overlooking is affected by a number of factors including in particular:
 - a) The distance between buildings;
 - b) The presence of openings;
 - c) Whether properties face each other directly or are offset;
 - d) Changes in levels across a site and relative to neighbouring properties; and
 - e) The types and use of rooms facing each other.
- 4.2.46 A minimum separation distance of 21 metres will be required between opposing faces to achieve a degree of privacy between habitable rooms of two-storey dwellings. Habitable rooms do not include bathrooms, hallways, utility rooms and circulation space. Where housing is proposed with main living rooms above ground floor level it is necessary to have a greater separation distance of 27.5 metres between opposing faces

to achieve both privacy and adequate visual separation. Care must be taken when windows overlook adjacent flank walls to ensure overshadowing and any overbearance are avoided. Where a two storey dwelling faces a flank wall on a two storey building, a minimum separation distance of 12.5 metres will be required. Where a two storey dwelling faces a flank wall of a three storey building, a separation distance of 15.5 meters will be required. Where there are changes in the ground level between dwellings, applications will need to take account of this and minimum separation distances increased where necessary.

Figure 6

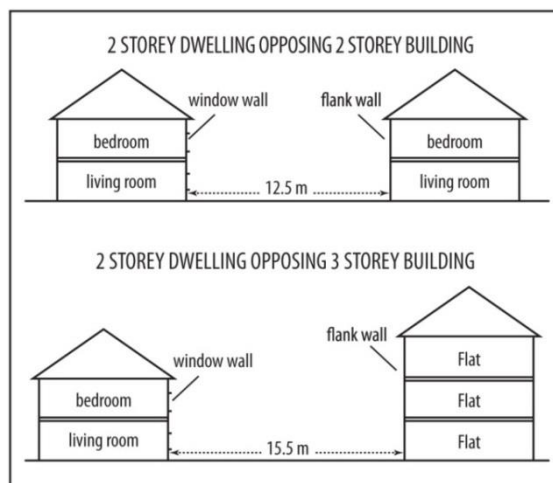
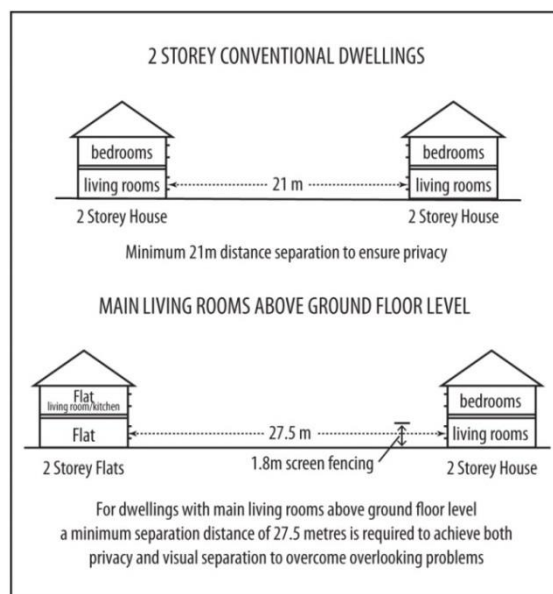

Figure 7



Overshadowing

4.2.47 Overshadowing occurs where a development reduces the supply of light to a neighbour’s property or garden. Developments should be designed to minimise impacts upon the amenity and living conditions of neighbours.

4.2.48 The extent of overshadowing and the severity of its impacts upon amenity will depend upon:

- a) The aspect of the development relative to the path and height of the sun;
- b) The size of the new development;
- c) The position of dwelling(s) relative to neighbouring properties;
- d) The nature and use of the rooms affected by shadowing;
- e) The presence of existing features that obstruct light;
- f) Ground levels; and
- g) Distance between buildings

Overbearance

4.2.49 Where new dwellings are located and are of sufficient height and mass to dominate neighbouring dwellings, this will not be acceptable.

Figure 8

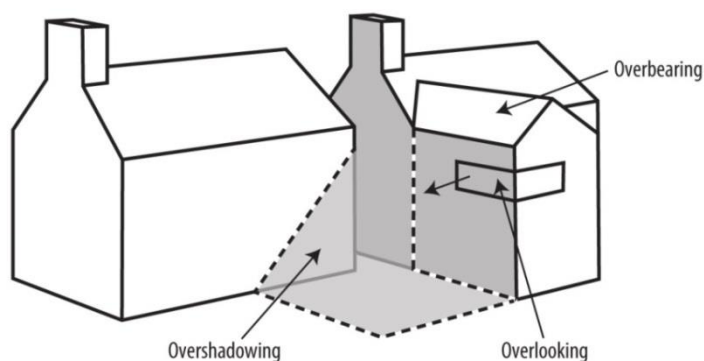

Noise

4.2.50 Disturbance caused by noise may potentially be an issue where neighbouring uses and associated patterns of activity are dissimilar. Accordingly, careful consideration should be given to the siting of residential development where disturbance may be caused by established lawful uses, particularly in the late evening and early morning.

Lighting

4.2.51 Artificial light sources may cause significant harm to residential developments. New street lights and security lighting within developments should be positioned in locations where they do not shine directly in dwelling windows, but provide sufficient lighting for safety and security on the street.

4.2.52 The type of lighting selected should be relevant to the local context, character and use of the area and minimise the impact of light pollution as well as being as energy efficient as possible.

4.2.53 The design and position of lighting should complement and support the provision of landscaping.

- 4.2.54 There should be a clear strategy for the provision of lighting within an area in support of the primary movement patterns. The decision to light or not light public spaces should be well thought through.

Trees, hedges and landscaping

- 4.2.55 The Council will expect to see important trees and hedges retained through incorporating these features into the design and layout of developments. An arboriculture report can help identify the health and amenity value of trees on the site and so inform this process.
- 4.2.56 Landscaping should be used to improve the attractiveness of an area, support biodiversity and positively protect property. Where trees and shrubs are planted, care must be taken to ensure that they do not obstruct visibility into or out of public areas. Where they are planted alongside footpaths or cycle ways they should not obscure views along the length of the route or provide for hiding places. It is essential therefore that appropriate species are selected and necessary maintenance regimes are set in place.
- 4.2.57 Defensive planting such as thorny or spiny shrub species should be used to help protect vulnerable boundaries and buildings.
- 4.2.58 Landscaping must be carefully sited and designed so as not to obscure existing CCTV, lighting, signage, windows and entrances.
- 4.2.59 Trees should not be planted in places which will assist as climbing aids into or onto properties.

Sustainability

Energy conservation and efficiency

- 4.2.60 Development should incorporate measures within its design, layout and orientation, in the use of materials and operation of services that promote energy efficiency and support energy conservation. Low carbon energy sources should be incorporated where appropriate. Energy storage should be considered to increase the efficiency of renewables where applicable. As properties become increasingly well insulated, heated and air-tight adequate ventilation, shading and cooling also need to be considered, while maintaining energy conservation.

Habitats

- 4.2.61 The opportunities to incorporate and enhance wildlife habitat features and species should be taken, particularly those identified as priorities by the Worcestershire Biodiversity Partnership, both within the layout of the proposal and through sympathetic construction techniques. This ensures connectivity and sufficient suitable habitats to support viable and sustainable populations.

Resources

- 4.2.62 Developments should seek to reduce the volume of resources consumed and should help to promote more sustainable lifestyles. Consideration should be given to water efficiency and lifecycle costs of materials.

Passive Solar Design

- 4.2.63 Sensitive layout and orientation of buildings can have a considerable impact on the amount of sunlight and overshadowing within a development. Good building design should seek to trap the heat generated by the sun in order to reduce consumption of conventional fuels. Layouts which are planned with the orientation of the sun in mind can be described as having Passive Solar Design. Solar gain can be beneficial in providing heat but can also result in overheating; therefore layouts should be carefully designed.

Safety and Security

Public and private space

- 4.2.64 It is important to clearly define public, private and communal spaces, which should be clearly defined by appropriate physical or symbolic boundary treatments. The type and design of these should be informed by the local context.

Secured by Design

- 4.2.65 The Council supports the Secured by Design Scheme; applicants are expected to meet those standards where possible.

Natural Surveillance

- 4.2.66 Natural Surveillance from dwellings should be ensured to provide safe and secure places to live. Blank walls along road ways, footpaths and cycle ways can create unwelcoming and oppressive routes. Siting dwellings which overlook or open onto routes through and between sites can reduce antisocial behaviour, littering and crime.
- 4.2.67 As far as possible, pedestrian and cycle routes should be overlooked by development to allow for natural surveillance.
- 4.2.68 Natural surveillance should be incorporated quite easily into a development scheme through a number of design features which should ensure:
- i. fronts of buildings face the public realm at ground level, particularly rooms with a lot of activity such as living rooms and kitchens and avoiding garage and bin stores;
 - ii. corners are built positively and should not provide 'dead' frontages;
 - iii. entrances to the property are overlooked;
 - iv. car parking spaces are overlooked by the property;
 - v. flatted developments maximise front doors onto the street and ground floor flats should generally have separate entrances as this minimises the shared access space;

- vi. the primary access to buildings are from the public realm with well-defined entrances at frequent intervals;
- vii. housing layouts are designed so backs face backs (private space to private space);
- viii. a change in road surface material;
- ix. pedestrian and cycle routes should be clear, direct and well overlooked from surrounding buildings and spaces. They should be generous in width with good visibility along their entire length. Sharp bends, blind spots and secluded access points should be avoided;
- x. careful consideration is given to the design of corner plots to ensure that they make a positive contribution to the street-scene on both sides and provide sufficient natural surveillance; and
- xi. public open space is prominently positioned with high levels of natural surveillance from surrounding buildings and roads.

4.3 New dwellings in Conservation Areas or near to Listed Buildings and non-designated heritage assets

- 4.3.1 New residential developments within Conservation Areas will need to pay special attention to the street scene and must preserve or enhance the character of the area.
- 4.3.2 Where new residential developments are proposed near to Listed Buildings, great care will need to be had to ensure the Listed Buildings' setting is sustained and enhanced. Appropriate siting and design of the new development will need to be considered, as well as materials, layout and appropriateness.
- 4.3.3 New residential developments which are located near to a non-designated heritage asset will need to be appropriately designed to not detract from the setting of that asset. A non-designated heritage asset is an asset of historic value which is not designated nationally, but is of local importance. Please be aware the Council do not have a definitive list of non-designated heritage assets, they are often identified through the submission of planning applications.

Please note - Proposals within a Conservation Area or for or near a Listed Building should be discussed with the Conservation Officer prior to applications being submitted.

5. Conversion of Rural Buildings to Residential Use

- 5.1 Converting buildings to residential use allows the survival of the character and form of existing buildings while giving them a new lease of life. A well-designed conversion should retain the original, utilitarian character of the building, allowing ample use of the existing structure. Buildings which have become so derelict that they could be brought back into use only by complete or substantial reconstruction fall outside the scope of this guidance.
- 5.2 Factors to consider include:
- a. The building should have some intrinsic conservation value and should be suitable for conversion. The new use should conserve the form and character particularly where buildings are listed, are of listable quality or form part of a particularly fine group of traditional buildings.
 - b. The building should be large enough for the proposed use without the need for significant enlargement or alteration.
 - c. The building should be structurally sound and capable of conversion without the need for major rebuilding.
 - d. The building should have safe and adequate access to a public road and its conversion should not materially increase traffic on narrow country lanes leading to a demand for their improvement.
 - e. The re-use should not lead to the provision, improvement, renewal or extension of utility services which would be damaging to the landscape.
- 5.3 Where planning permission is granted for the conversion of buildings to a dwelling, the residential use and any associated use rights will only extend over the land within the approved curtilage. This is usually denoted by the red line on the approved site plan.
- 5.4 Where a building is of archaeological interest, is within or close to a site of archaeological interest, advice should be sought from Worcestershire County Council Archaeological Service on any survey or recording work that may be needed to further knowledge of the site. This may also apply to some farmsteads, which have been settled for many years and contain a wealth of historic interest.
- 5.5 Agricultural buildings are characterised by large unbroken roof slopes and few window and door openings. Large unbroken roof slopes should be respected as they can be seen from some distance, so new opening would normally be opposed, and dormers and similar structures will not be allowed.
- 5.6 On less visible slopes flush fitting roof lights may be possible. An alternative to roof lights may be a suitable opening in the gable end to supplement light levels. Existing openings should be utilised and new openings will be resisted. Where new openings are deemed necessary, they must be in keeping with the character of the original building and be located on the inside elevation, away from public view.
- 5.7 Existing features of interest should be retained and incorporated in the design of the conversion. This includes such items as external steps, lanterns, dovecotes, ventilation slits, barn door openings and lean-tos etc. Proposals should seek to enhance the building or group of buildings where there have been previous unsympathetic additions, to an otherwise attractive buildings, the Council will seek their removal.
- 5.8 Wagon arches should be fully glazed and if possible the great doors should be retained and sealed. If glazing is used, the vertical dimensions should be emphasised with no obvious signs that the conversion forms two floor levels. The glazing of wagon arches

can often provide illumination to the main internal spaces of the building and borrowed light to other rooms.

- 5.9 Rain was often allowed to run directly off the eaves of farm buildings. Any gutters and downpipes in rural conversions should therefore be discrete, of a dark colour and made of metal.
- 5.10 Rebuilding should be kept to a minimum and where considered to be required must be quantified on the submitted drawings. Existing materials should be re-used or new/ reclaimed traditional materials incorporated that blend harmoniously with old.
- 5.11 Chimney stacks are inappropriate in rural conversions since they damage the character of a traditional rural building by introducing domesticity. Alternative treatments such as a small metal flue may be acceptable provided that they are sensitively positioned. Small balanced flues are acceptable for oil or gas fired heating but fuel tanks sited to comply with Health and Safety Regulations can be intrusive features and will need to be sensitively sited.
- 5.12 Providing adequate private parking for converted buildings can be challenging. Parking should be located away from the main façade of the building, either within a traditional yard area or within other agricultural buildings in the vicinity.
- 5.13 In rural conversions proposed new areas of hardstanding for parking will be resisted, as this will both impact on the rural nature and character of the building and wider area. The re-use of existing stone, setts or stone blocks is encouraged. These are more likely to be in keeping with the farm building.
- 5.14 Regard will be had for the materials used to create an access. No access will be permitted to run over open fields where this would be especially visible in the open countryside. Where an agricultural building is part of a farmstead, use of the existing access will be required.
- 5.15 In rural conversions tall brick walls, elaborate gates and gate piers at the entrance to the conversion will not be permitted, as this will not reflect the agricultural roots of the building(s).
- 5.16 Planting will not be accepted as an excuse for poor design and disregard to the original building.
- 5.17 Old farm buildings are often used as roosts for owls or bats and provide valuable habitats for other birds and animals. A Phase 1 Habitat Survey is likely to be required to identify the ecological potential of the site. A Phase 1 habitat survey is a method of identifying semi-natural vegetation and other wildlife habitats and must inform the planning application. The system is the standard method for habitat surveys across the UK and needs to be undertaken by a qualified ecologist. Where the nature conservation interest is considerable, mitigation measures will be required or permission could be refused.
- 5.18 Where consent is given for the conversion of a traditional rural building, it is likely that the Council will include a condition to remove Permitted Development Rights for extensions and alterations, to ensure the building remains rural in character.

Figure 9

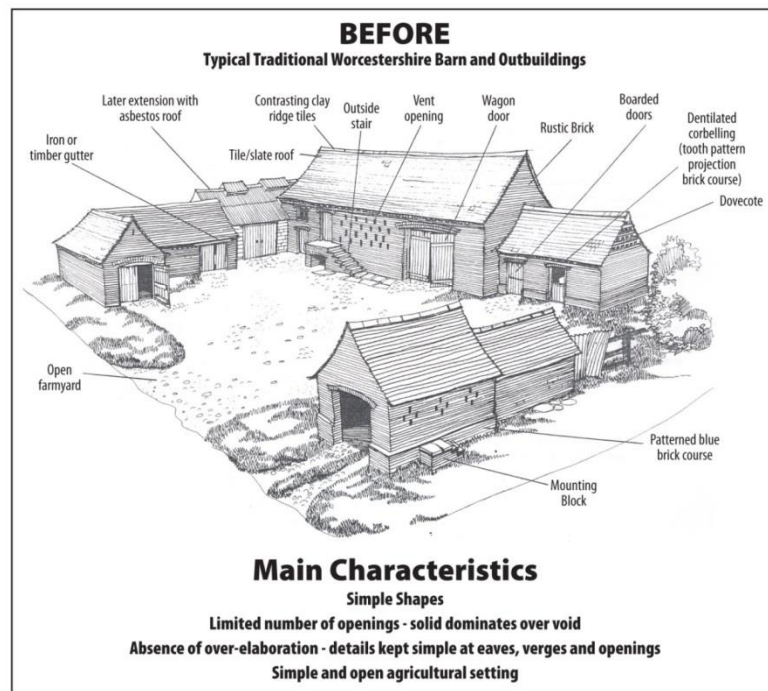

Figure 10

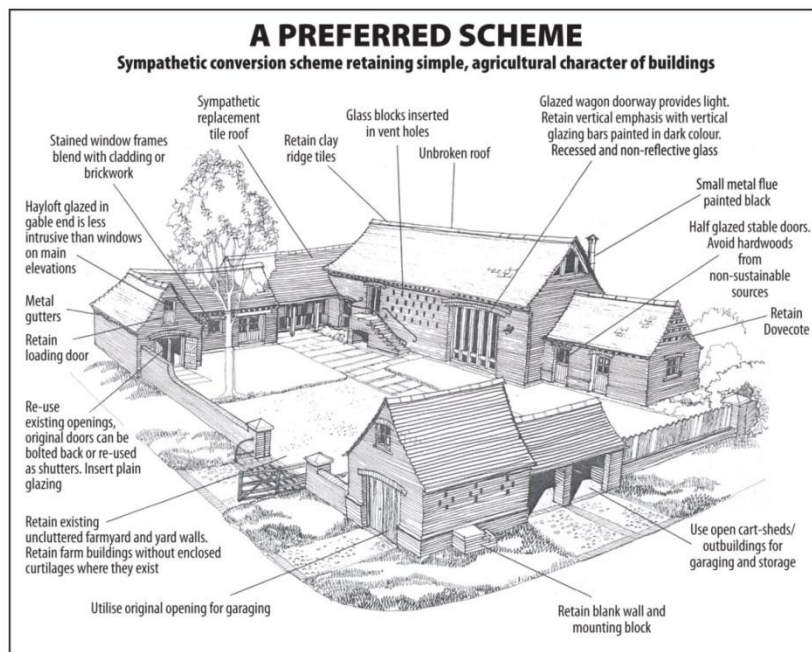
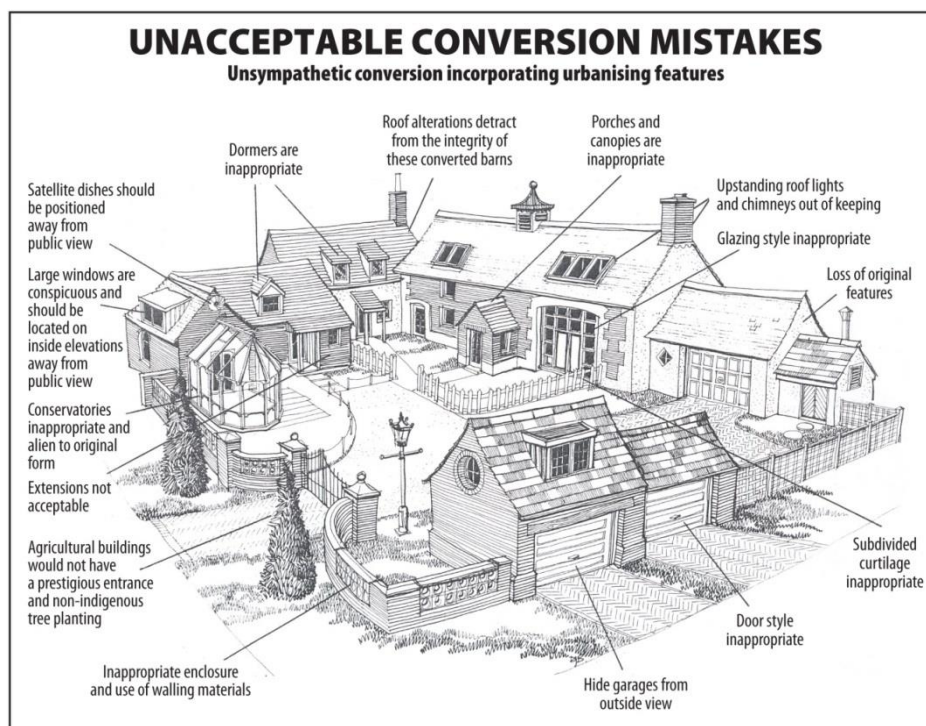

Figure 11



6. Non-Residential Development

6.1 Key considerations

6.1.1 Non-residential development is defined as all types of Use Classes except those under Class C of the Use Class Order 2016 (or subsequent).

6.1.2 Guidance is provided for the following types of non-residential development:

- Retail units;
- Shopfronts;
- Commercial/Industrial buildings;
- Change of use;
- Agricultural buildings; and
- Equestrian development.

6.1.3 All non-residential development must take account of the following considerations:

- BREEAM;
- Impact on neighbouring amenity; and
- Local character.

6.1.4 **BREEAM** – BREEAM is the Building Research Establishment’s Environmental Assessment Method. In line with Policy 15 ‘Climate Change’ all new non-domestic development must be assessed against the BREEAM assessment method (or any other national scheme which supersedes it). Where this requirement affects the viability of the scheme justification must be provided for not fully meeting this requirement.

- 6.1.5 **Impact on neighbouring amenity** – Developments should not impact on neighbouring amenity of buildings, regardless of their use. This includes through overbearance, overshadowing and overlooking nearby buildings and developments.
- 6.1.6 **Local character** – Developments should respect and enhance the local character through the use of appropriate materials, siting, scale and massing.
- 6.1.7 **Conservation Areas and Listed buildings** – Non-residential developments within Conservation Areas will need to pay special attention to the Conservation Area as a whole and must preserve or enhance the character of the area. New development should not adversely impact the significance of heritage assets, which include Conservation Areas and Listed buildings, notably Listed Buildings, where there is a statutory requirement to consider the impact on setting, and Conservation Areas. This would include development outside of a Conservation Area but within the setting. The setting of non-designated heritage assets must also be considered. A non-designated heritage asset is an asset of historic value which is not designated nationally, but is of local importance. Please be aware the Council do not have a definitive list of non-designated heritage assets, they are often identified through the submission of planning applications.
- 6.1.8 As with any development near heritage assets, designated or not, applicants need to use an appropriate Heritage Statement as a starting point, and they also need to carry out a setting assessment using Historic England guidance (for more information see the Historic England website: <https://historicengland.org.uk/advice/hpg/has/setting/>).

Please note - Proposals within a Conservation Area or for or near a Listed Building should be discussed with the Conservation Officer prior to applications being submitted.

6.2 Commercial Development

- 6.2.1 Better designed buildings, landscapes, townscapes and places contribute towards more productive employees, a healthier and happier workforce, and communities are more likely to be committed to the maintenance and improvement of their surroundings.
- 6.2.2 Planning permission will only be granted for new commercial and industrial buildings which are of high quality design and are appropriate for their use and context. Development will not be permitted where it is considered to have a detrimental impact on the townscape or landscape character. The following considerations should be taken into account when designing a commercial/industrial scheme:
- Scale;
 - Layout;
 - Access;
 - Materials;
 - Landscaping;
 - Noise;
 - Boundary treatments;
 - Bin storage; and
 - Parking.
- 6.2.3 **Scale** - The proposed development should be in scale with surrounding developments and not be visually intrusive due to its scale and massing. Where possible large

buildings should minimise their impact through having low building heights and use of a curved roof.

- 6.2.4 **Layout** - The relationship between the proposed development and existing buildings and features in the area should be considered when designing the proposal or determining the location on the site.
- 6.2.5 All new commercial development will be expected to create continuous active frontages and minimise blank walls and fencing. There should be a clear relationship between any new and existing development and the building should be well integrated into its surroundings.
- 6.2.6 **Access** - Entrances should be directly visible and easily accessible. Access and circulation should contribute to a network of direct and connected routes within and beyond the site.
- 6.2.7 **Materials** – Commercial developments should be constructed to produce a visually attractive scheme. Materials, building methods and details in the design should aim to enhance the local distinctiveness of an area. Where there is no precedent set for specific types of materials to be used, a high quality area with a distinct character needs to be created, either from traditional or more modern materials. It is the degree to which any material is appropriate to its surroundings and its function that should determine its use.
- 6.2.8 **Landscaping** - A balance of both hard and soft landscaping should be included to ensure that quality visual spaces are enhanced and their use, both night and day, encouraged. Landscaping can also include appropriate screening to help reduce noise, light and air pollution.
- 6.2.9 Landscaping proposals should enhance the existing built and natural environmental features already present in the location, for example, careful retention of healthy trees can give a sense of maturity to a new development and can be a significant asset to any development. The use of native species and regard to soil conditions, drainage, shelter and space should be undertaken when designing the landscaping element of a scheme.
- 6.2.10 Proposed landscaping schemes should be included in planning applications and planning permissions will not be granted where the site is overdeveloped and the landscaping is piecemeal.
- 6.2.11 **Noise** - The scale, nature and frequency of vehicles that service industrial businesses can be a major source of conflict with neighbouring activities, including other industrial uses. The design objective is to manage noise, disturbance and potential danger from deliveries, servicing and storage in order to reduce the impact on neighbours and the general appearance of the area. The best place for this to occur is behind frontage buildings, or to the rear of the main building.
- 6.2.12 Mitigation measures may be needed, such as earth bunds, reed beds and tree planting to reduce the impact of noise or air quality.
- 6.2.13 The location of the servicing areas, routes in and out of the site and location of mitigation measures combined should reduce the impact of noise and air quality.
- 6.2.14 In addition, working hours may be need to be restricted especially where there are residential areas nearby in order to reduce disputes and conflicts.
- 6.2.15 **Boundary treatments** – must be appropriately designed and utilise existing features and vegetation, such as hedgerows and mature trees.

- 6.2.16 The choice of boundary treatments should relate to the wider physical and social context of the surrounding environment and seek to make a positive contribution to the character of the area and the building(s).
- 6.2.17 Where they are adjacent to public space, boundary treatments should be transparent to allow clear views into and out of the site and not hinder vision on the highway, particularly at road junctions.
- 6.2.18 **Bin storage** – Bin storage areas must be well designed and located in relation to properties. They should be located no more than 30 metres from the access roadway and be free from steps and kerbs.
- 6.2.19 Provision should be made for storage and collection of both residual waste and recyclable waste. A compactor could be considered for offices and light industrial developments for residual waste only with separate provision for recycling.
- 6.2.20 **Parking** - Adequate parking should be provided, with areas for service vehicles to park and turn if necessary. Parking areas should include some landscaping features and screening in order to reduce the visual impact. Cycle parking must also be provided along with cycle paths and footpaths in and out of the site. Adequate cycle storage of an appropriate size should be included as part of the development. These standards are set out by Worcestershire County Council Highways Department. Please refer to their specific requirements regarding cycle storage.

6.3 Agricultural buildings

- 6.3.1 Successful building design is not just a matter of what a new agricultural building will look like. In the countryside it is important to look beyond that to consider how new development will relate to its landscape setting and its impact on any settlement where it is to be located.

PD BOX – Some agricultural development can be undertaken via permitted development, although prior approval rather than a full planning application may be required

- 6.3.2 Buildings for agriculture and forestry are not considered inappropriate development in the Green Belt, however, the preservation of the Green Belt remains of paramount importance to the Council and it is important that the visual amenities of the Green Belt are retained and enhanced through ensuring new buildings are appropriately designed.
- 6.3.3 The following factors should be considered prior to a project being designed and commenced:
- Grouping;
 - Access;
 - Viewpoints;
 - Skyline;
 - Materials;
 - Colour; and
 - Landscaping.
- 6.3.4 **Grouping** - When seen from a distance it is not the siting of a building which is apparent but its scale in relation to adjacent buildings. Tight clusters of buildings generally look more settled in the landscape than scattered ones. For this reason, new buildings

should form part of a group rather than stand in isolation. The siting of new proposals where there are listed buildings is of particular importance. New development sited within a group of other buildings will also benefit from surveillance and be less vulnerable to crime than if located on a detached site or screened site.

Figure 12

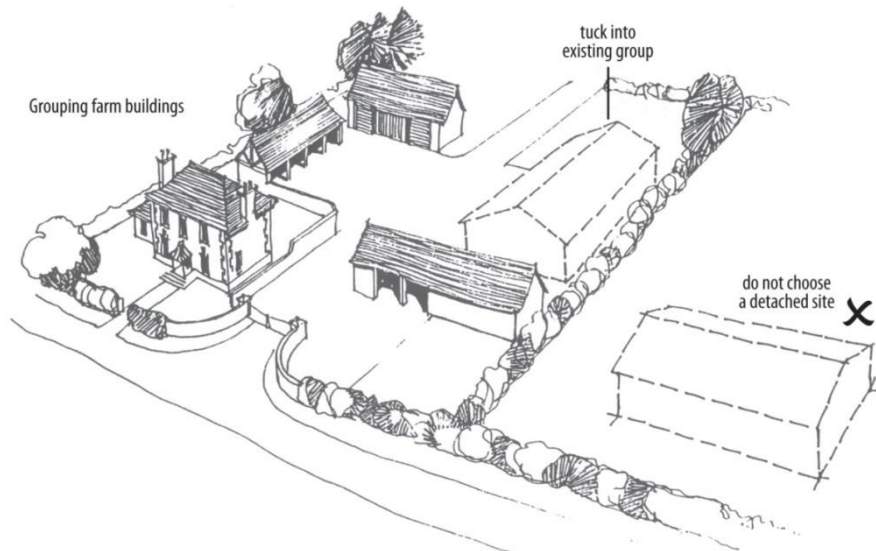

Figure 13

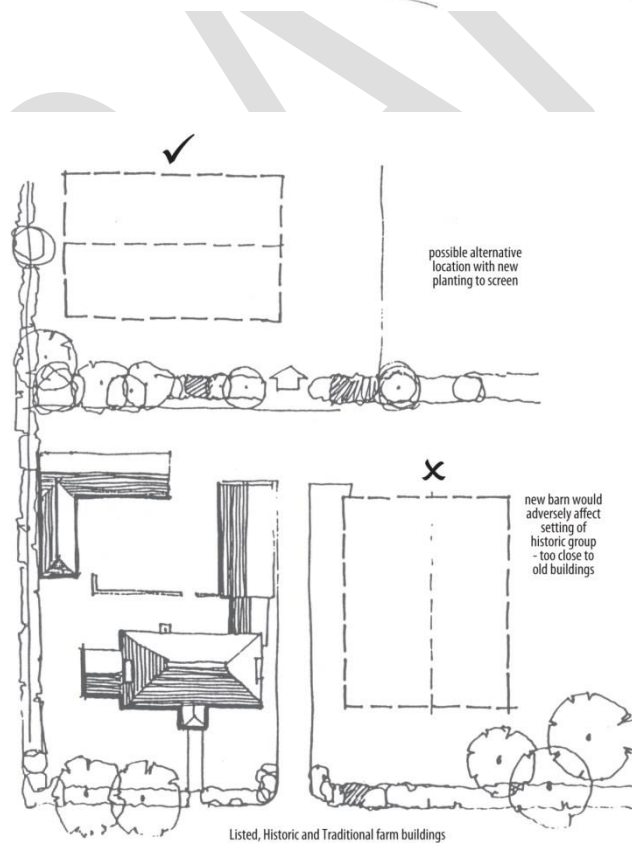
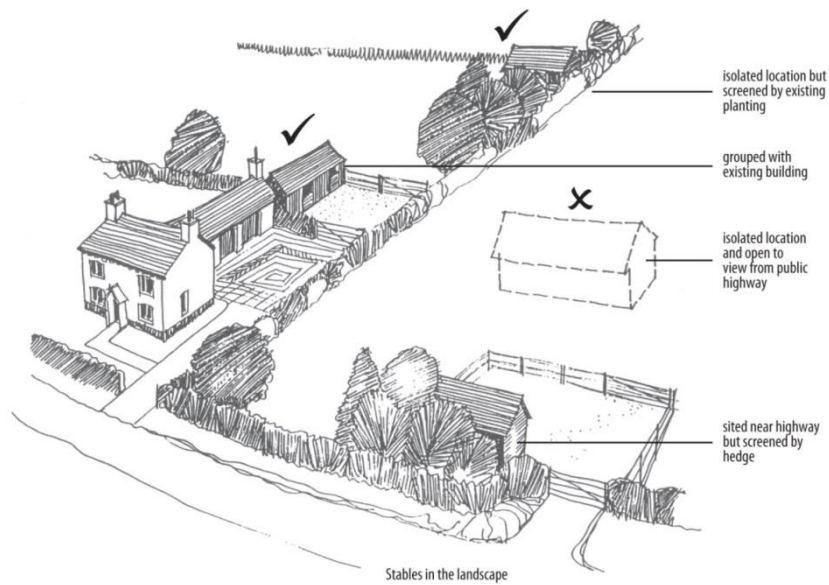

Figure 14



6.3.5 **Access** - New agricultural buildings should be located close to existing accesses or exiting buildings where possible to ensure long tracks and large areas of hardstanding are not required.

6.3.6 **Viewpoints** - A modern farm building by nature of its scale and materials can form a prominent feature in the landscape. It is important therefore, that views into and out of the site are accounted for.

Figure 15

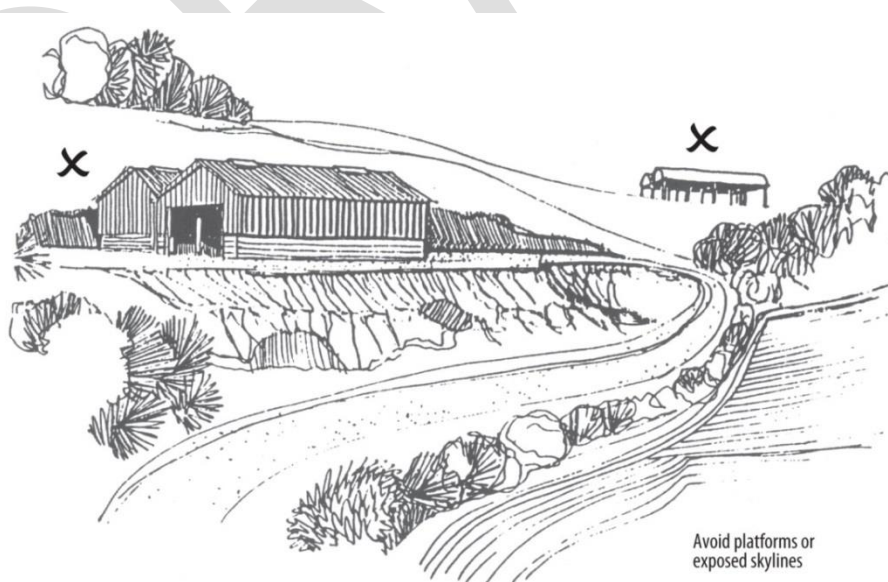

6.3.7 **Skyline** - New buildings should respond to contours and the natural form of the land by fitting into folds or valley bottoms and avoiding platforms or exposed skylines or ridges.

Figure 16

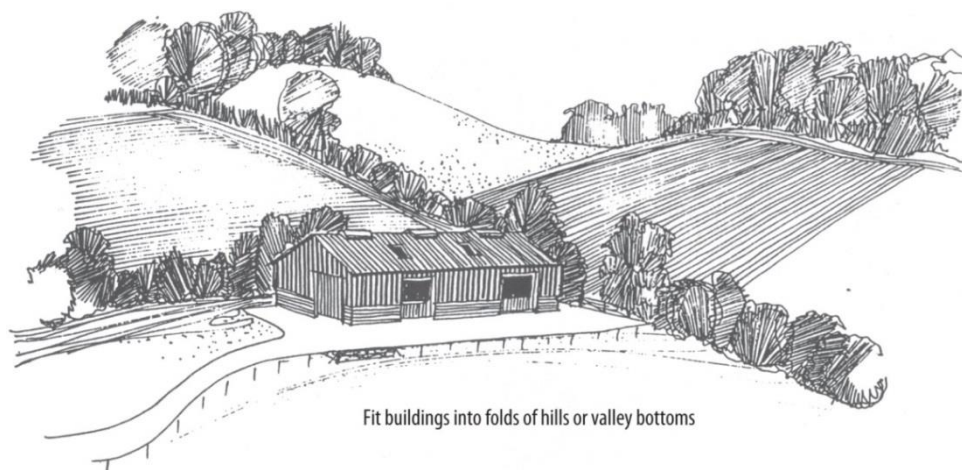

6.3.8 **Materials** - Choice of materials should always take account of the adjacent landscape, buildings, walls and gates. Materials should be appropriate for the purpose. Over engineered buildings will not be permitted.

6.3.9 **Colour** - Generally, colours should be 'earth colours' such as browns, greys or greens to reflect local materials e.g. red bricks with a rustic finish. Juniper green (12B29) and Vandyke brown (08B29) are example colours which should be used. There is no need for new buildings to match the colour of existing buildings where they are sited in or nearby existing buildings.

Figure 17



6.3.10 **Landscaping** - Landscaping will be encouraged to soften the appearance of agricultural buildings.

Figure 18

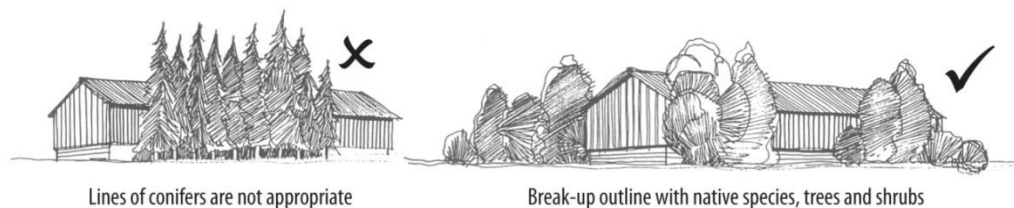

6.3.11 **Other material considerations** - The effects of noise and smell on nearby dwellings should be taken into account in detailed site and design planning. Agricultural buildings that are domestic in appearance shall be refused.

6.3.12 **Physical security standards** – the design and construction of walls, roofs and roof lights, external doorsets, windows, roller shutters and grilles should take into account the guidance issued in the Secured by Design Commercial Developments with a view to the development achieving the SBD Commercial Award.

6.4 Equestrian developments

6.4.1 The keeping of horses on the smallest scale is likely to require development of some kind and it is rare for equestrian development not to need planning permission.

6.4.2 Regardless of the type of development proposed – be it a simple field shelter, stabling or new access and tracks – consideration will need to be given to a number of factors including siting, scale, design, materials, colour and landscaping. Fitting in with the character of the landscape should be a key consideration of the design.

6.4.3 The change of use of land, from agricultural to equestrian land may be required. If poorly designed and managed, stabling can contribute to the rapid spread of disease, cause injury and pose significant fire risks.

6.4.4 Stables and shelters should be kept to a minimum and consist of only essential facilities, therefore stables should:

- Contain no more than a small tack room/hay store and the number of stables should reflect the number of horses present on the land. They should not be large enough to enable easy conversion to other uses;
- Have doors a width of 1.25 metres;
- Have stables a minimum size of 3.65 metres x 3.65 metres (12ft x 12ft) in accordance with the British Horse Society recommendations;
- Stable height should be between 2.8 metres and 3.3 metres (9ft to 11ft);
- Be constructed of timber with no more than a single course of brickwork for the stables to sit on;
- Design floors to ensure good drainage, taking stable waste away from the horse;
- Include adequate ventilation and air circulation. There should be a good flow of air throughout the building without unnecessary draughts;
- Be sited as to reduce the amount of hardstanding or track required;

- Be closely related to existing groups for buildings or adjacent to natural screening; and
 - Allow easy access to grazing land.
- 6.4.5 It will be down to the applicant to provide reasonable justification(s) if an application differs to the above.
- 6.4.6 Where a manège is proposed, it should be no larger than 40m x 20m. As a flat surface is needed for a manège is it essential to choose a location where the re-grading of land is limited or not necessary. Manèges should be located close to the corners of a paddock and boundaries and be close to existing buildings and as inconspicuous as possible.
- 6.4.7 Light pollution is a growing concern. External lighting can make a site appear prominent in the landscape and affect the valued sense of rurality. Any planning applications should set out clearly whether or not artificial lighting is proposed, and if so, how light pollution will be minimised. Floodlighting will be strongly resisted.

Figure 19

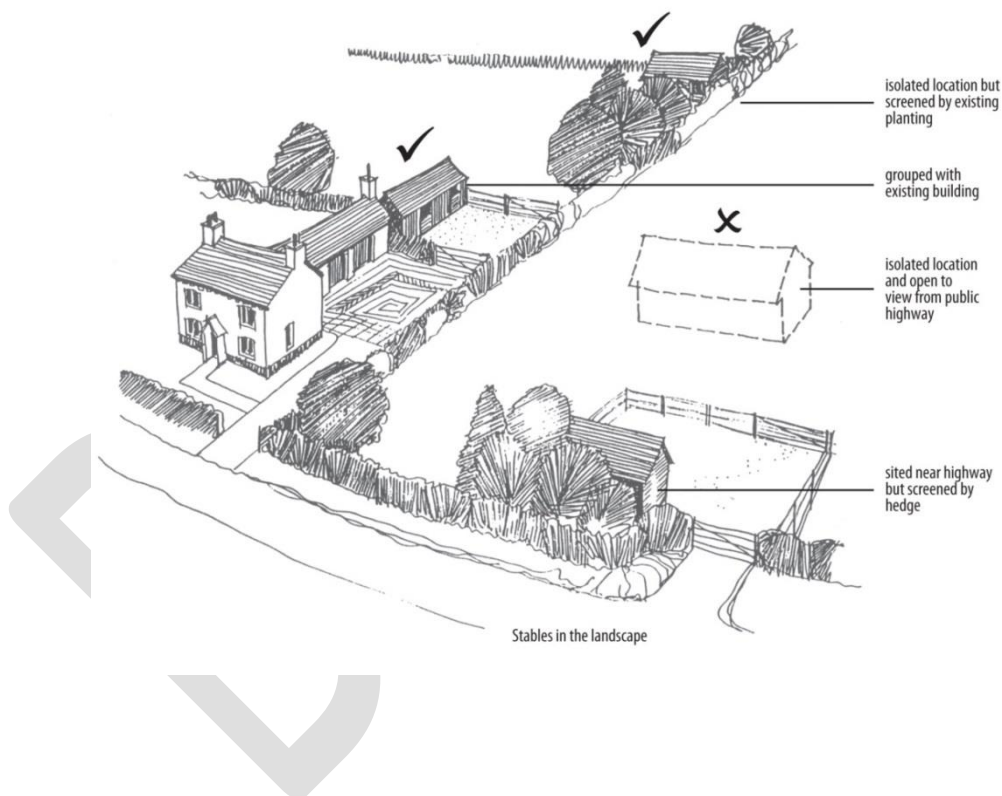
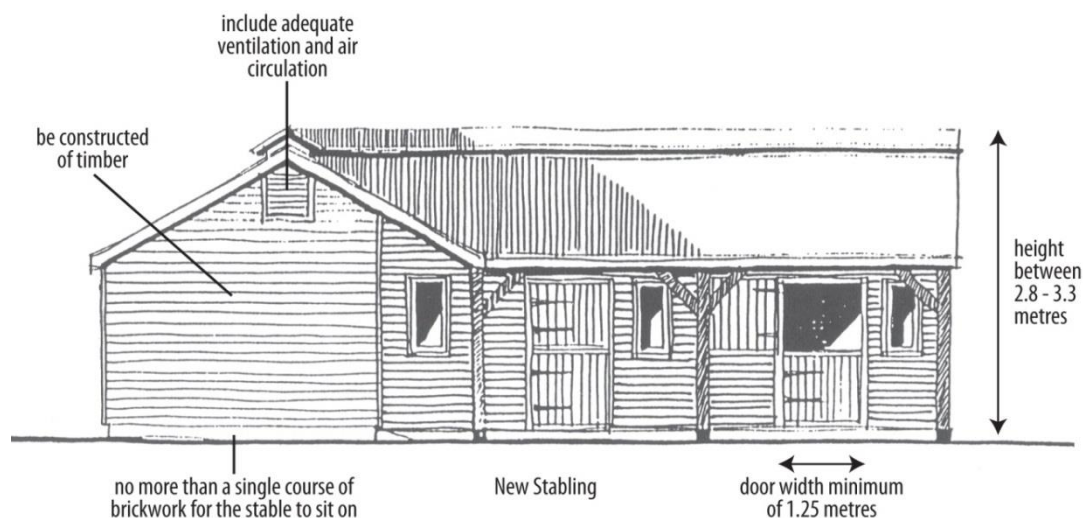

Figure 20



6.5 Retail units

- 6.5.1 An emphasis on good quality design enhances the character of a shopping environment, encourages investment and spending and brings benefits to all commercial interests.
- 6.5.2 Retail developments should be located in accordance with the retail hierarchy set out in Policy 30 of BORLP4. Retail proposals that are not in accordance with the retail hierarchy as set out in Policy 30 will not be favourably considered.
- 6.5.3 Retail proposals on the edge of settlements will not be favourably considered unless all other options have been discounted and there is an overwhelming need for retail development.
- 6.5.4 The Council will pay close attention to the outside design of shops such as signage schemes, parking spaces, gradients and design of access pathways, particularly where a retail unit is proposed outside the pedestrianised core of the Town Centre.
- 6.5.5 Adequate bin storage for the size and scale of refuse the unit will create should be provided and be capable of being made secure. Bin storage should ideally be no further than 30 metres from the access road and should be free from steps and kerbs. Provision should be made for storage and collection of both residual waste and recyclable waste. A compactor could be considered for residual waste only with separate provision for recycling. Where retail and residential uses co-exist there needs to be sufficient storage for separate residential and commercial waste storage.

PD BOX – Certain types of retail uses can be changed to other uses via permitted development subject to certain limitations, restrictions, conditions and in some cases prior notification to the Council.

6.6 Shopfronts

- 6.6.1 Changing a shopfront is often seen as a way to modernize a shop, especially when ownership changes or when the use of a shop alters.
- 6.6.2 Good design need not necessarily be traditional and there are many locations where a well-designed modern shopfront will be acceptable but it must be sympathetic to the building above and the streetscape.
- 6.6.3 The presence of unsympathetic shopfronts already within a host building or features elsewhere within the street is not sufficient argument for the installation of equally unattractive or inappropriate features in a new shopfront. Betterment will be sought in all cases to improve the character and appearance of the street scene and complement and enhance features of the building in question.
- 6.6.4 New and replacement shopfronts must:
- Relate to the building of which it is an integral part;
 - Respect the proportions and architectural detailing of the building;
 - Ensure that the ground floor is not divorced from the rest of the building;
 - Reflect the surrounding character of the area; and
 - Take account of the variation of individual buildings where a shop occupies more than one building and the elevations are of different design.

Figure 21



- 6.6.5 A fascia should state only the name of the trader and, if necessary, the nature of the trade. Unnecessary duplication of a name on a single fascia will not be permitted.
- 6.6.6 The existence of any former unsuitable fascia should not influence the design of a replacement and any new fascia should not be applied over the top of an existing one.
- 6.6.7 New fascias must be of a scale and design in proportion to the design of the shopfront and height of the building as a whole. The fascia must be no higher than the bottom the first floor windowsill above (this includes shops and businesses on upper floors).

Figure 22



6.6.8 In areas where canopies are considered to be acceptable in principle, the following criteria will be applied:

- Traditional matt woven retractable or fan type blinds are preferred. They may be acceptable on listed buildings and in conservation areas but they will not be acceptable where they disrupt the architectural rhythm of unified terraces or street facades or where they obscure architectural detail or features.
- Continental 'Dutch' blinds, often made from shiny plastic are inappropriate in conservation areas and on listed buildings. Their structure obscures the fascia and introduces a dominant shape out of character with the street.
- Canopies and blinds should only be sited at ground floor fascia level.
- The design and siting of a canopy should complement the design of the building, be located within the pilaster and should respect the architectural subdivisions of doors and windows.
- New canopies must reflect any existing canopies on adjacent buildings in order to provide a continuous canopy frontage.
- Advertisements should relate solely to the trade or name of business and lettering on the canopy should be no greater than 150mm in height.
- Canopies and blinds should always retract fully into the fascia and should provide safe and adequate ground clearance (minimum 2.4m above ground floor level).

6.6.9 The Council seeks to resolve potential conflict between the security needs of shopkeepers and the detrimental appearance of shutters on townscape quality. There is no clear security advantage in using solid shutters rather than other security measures. Proposals for solid shutters will not generally be permitted. Ideally, security features should be considered from the outset of shop front design and included as integral parts of a shop front rather than added as an after-thought. A wide range of security products are available that specifically aim to enhance shop front security without detracting from the appearance. These include:

- Laminated glazing;
- Internal window security grilles;
- External removable window security grilles;
- Visually permeable roller shutters (internally or externally mounted)

Conservation Areas and development on or near to Listed Buildings

- 6.6.10 Extra care will need to be taken within Conservation Areas or on or adjacent to Listed Buildings to ensure that shopfront design does not adversely affect the special character of a Conservation Area or Listed Building and its setting.
- 6.6.11 Conservation Areas are areas of special architectural or historic interest. Development of shopfronts should preserve the special character of a Conservation Area and its setting. It is a legal requirement to pay special attention, in the exercise of planning functions, to the desirability of preserving or enhancing their character or appearance.
- 6.6.12 New traditional shop windows should draw the eye and be of interest, reflect the vertical emphasis of the building above. Window subdivisions, mullions and piers should be used for this purpose.
- 6.6.13 Existing features of traditional shopfronts such as pilasters, fascia's, old ironmongery and fire insurance signs should be retained for their historic interest and aesthetic value. Original fascias should always be retained as they form part of the design of the shopfront.
- 6.6.14 Where traditional shopfronts have previously been removed, these should be reinstated and a similar design used when replacing a shopfront. Traditionally most shopfronts were constructed in softwoods and painted. Occasionally hardwoods were used and finished with a glossy varnish. Hardwoods were never painted.
- 6.6.15 Particular attention will be given to materials in any proposal for a shopfront and no glossy surfaces such as acrylic sheeting or plastic will be permitted on Listed Buildings. The traditional material for shopfronts is timber and its continued use will be desirable in many instances.
- 6.6.16 Sensitive use of colour, respecting the age and setting of a building offers scope to improve the shopping environment and in general rich dark colour or those that are muted in tone give the most suitable background to highlight a window display.

Please note - Proposals within a Conservation Area or on or near a Listed Building should be discussed with the Conservation Officer prior to applications being submitted.

Figure 23

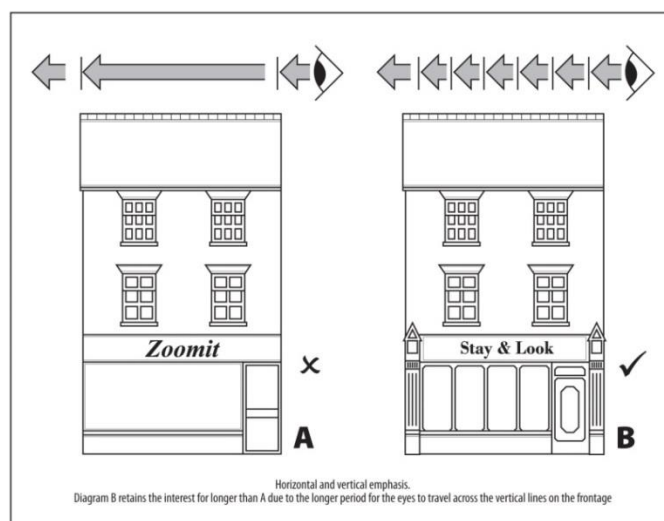

Figure 24

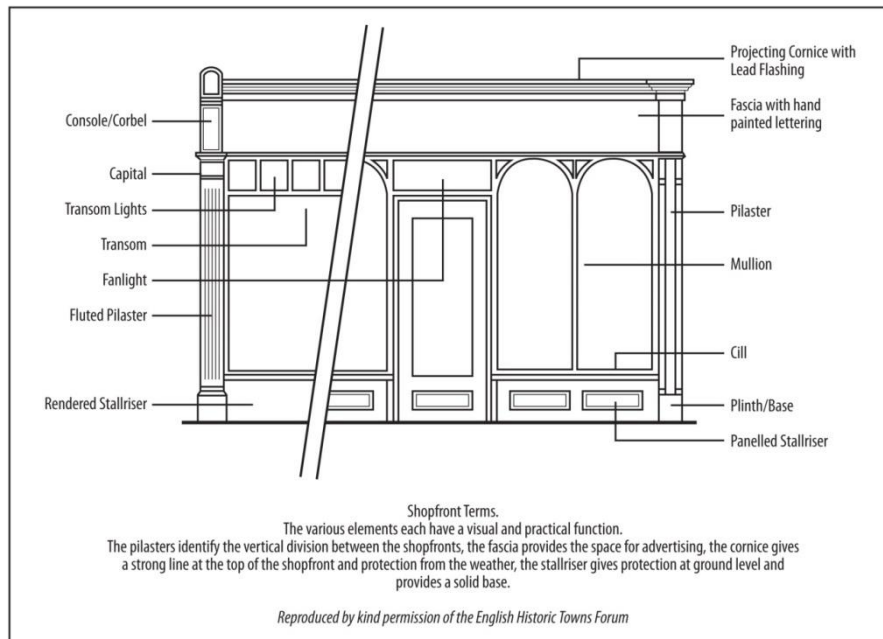
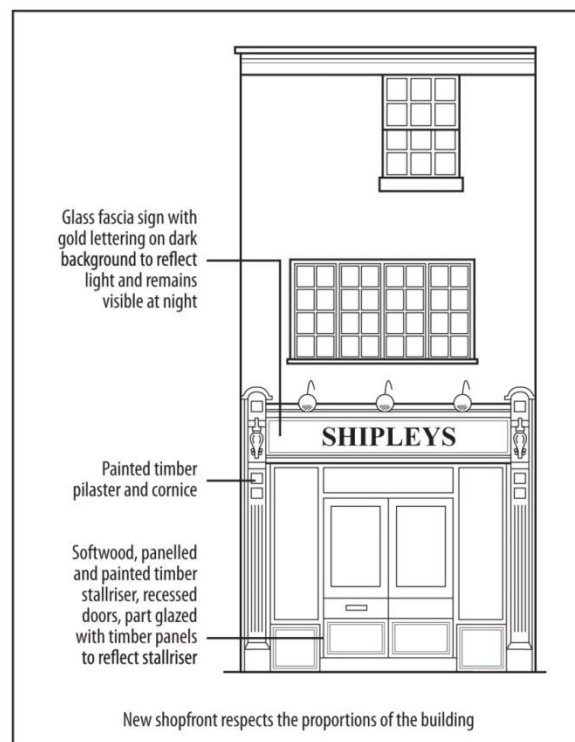

Figure 25



7. Advertisements and Signage

7.1 Key Considerations

- 7.1.1 Advertisements and signage can make a significant contribution to the character of an area and a shopfront or business. Poorly designed signage can detract from the character of a building and area.
- 7.1.2 Where advertisement consent is required, the council will expect the content of signs to be kept to a minimum.
- 7.1.3 Excessive advertisement should be avoided.
- 7.1.4 The Borough Council will expect corporate advertising to be adapted to fit buildings and townscape, particularly on Listed Buildings and in Conservation Areas.
- 7.1.5 Many advertisements require Advertisement consent, which is similar to planning permission.

“Poorly placed advertisements can have a negative impact on the appearance of the built and natural environment... Advertisements should be subject to control only in the interests of amenity and public safety, taking account of the cumulative impacts.”

NPPF Parts of Paragraph 67

DEEMED CONSENT BOX – A number of types of advertisements and signage have the benefit of deemed consent under the Town and Country Planning (Control of Advertisements) (England) Regulations 2007 (as amended) subject to the standard conditions and the conditions and limitations relating to that advertisement. Deemed consent means that certain types of development which comply can be undertaken without the need for advertisement consent.

7.2 Hanging or Projecting Signs

- 7.2.1 Well-designed hanging or projecting signs can add to the character of the area.
- 7.2.2 Hanging and projecting signs should relate to the size and scale of a building and neither appear over intrusive or too small. The materials and colours of the signage should reflect the fascia of a business and respect the character of the area.
- 7.2.3 Projecting signs should generally be in line with the fascia panel and not above the first floor sill level.
- 7.2.4 Traditional hanging signs denoting a trade may be suitable for historic buildings. They should be constructed in metal or wood and be hung from a wrought iron bracket.
- 7.2.5 The Council will not permit more than one projecting or hanging sign per shopfront in order to avoid street clutter and will not normally allow illuminated projecting signs.

Figure 26

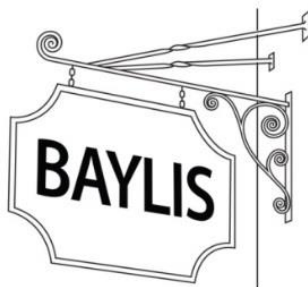

7.3 Free standing signage

- 7.3.1 Any free standing signs for business premises should be incorporated into a landscaping scheme and should preferably be located near the main site entrance.
- 7.3.2 Signs can include the logo of the business and the name of the business.
- 7.3.3 Appropriate colours should be used so as not to detract from street signage.
- 7.3.4 A proliferation of advertisements, especially on sites fronting main roads and railways, will not be permitted.

7.4 Window signs

- 7.4.1 Window signs provide a suitable method of advertising first floor premises.
- 7.4.2 Lettering on window panes of the shared advertising space of the ground floor trader can be used to advertise retail space on higher floors.
- 7.4.3 Lettering should generally be restricted to a maximum height of 0.3 metres (12 inches) unless exceptional circumstances prevail e.g large scale building.

7.5 Conservation Areas and Listed Buildings

- 7.5.1 Within Conservation Areas, advertisements and signage should reflect the character and nature of the Conservation Area and be of traditional materials or be traditional in appearance materials.
- 7.5.2 Advertisements on listed buildings will need to reflect the historic nature of the building and be of traditional materials and colours.
- 7.5.3 Illumination will not normally be permitted unless it is halo or down lit, but should be finalised in discussion with a Conservation Officer and the planning department.

8. Mixed Use Development

- 8.1 Mixed use developments will need to take into account the guidance in both the Residential Development – Creation of new dwellings and Non-residential Development sections of this High Quality Design SPD.
- 8.2 Mixed use developments should contain an appropriate mix of uses, depending on the location and nature of the proposal and policy requirements in the Borough of Redditch Local Plan No.4.